

JB SANITARY

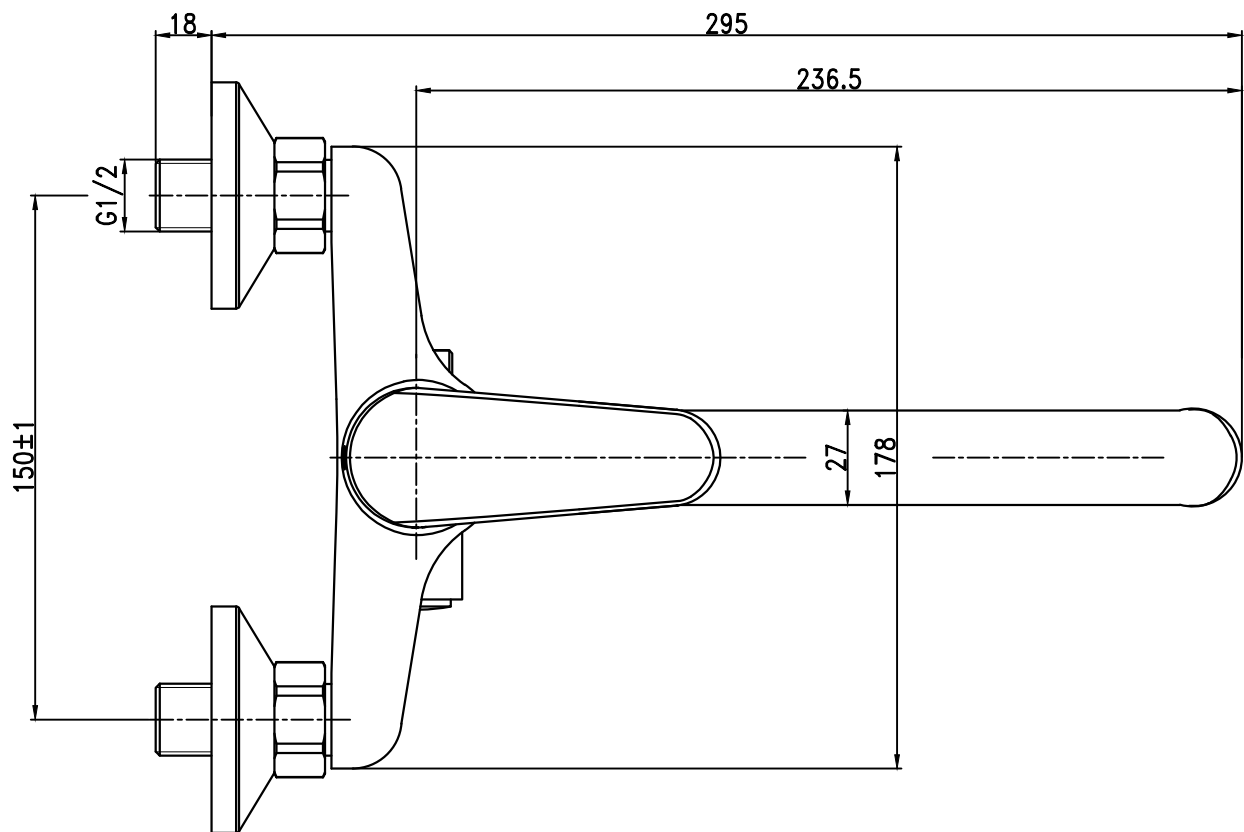
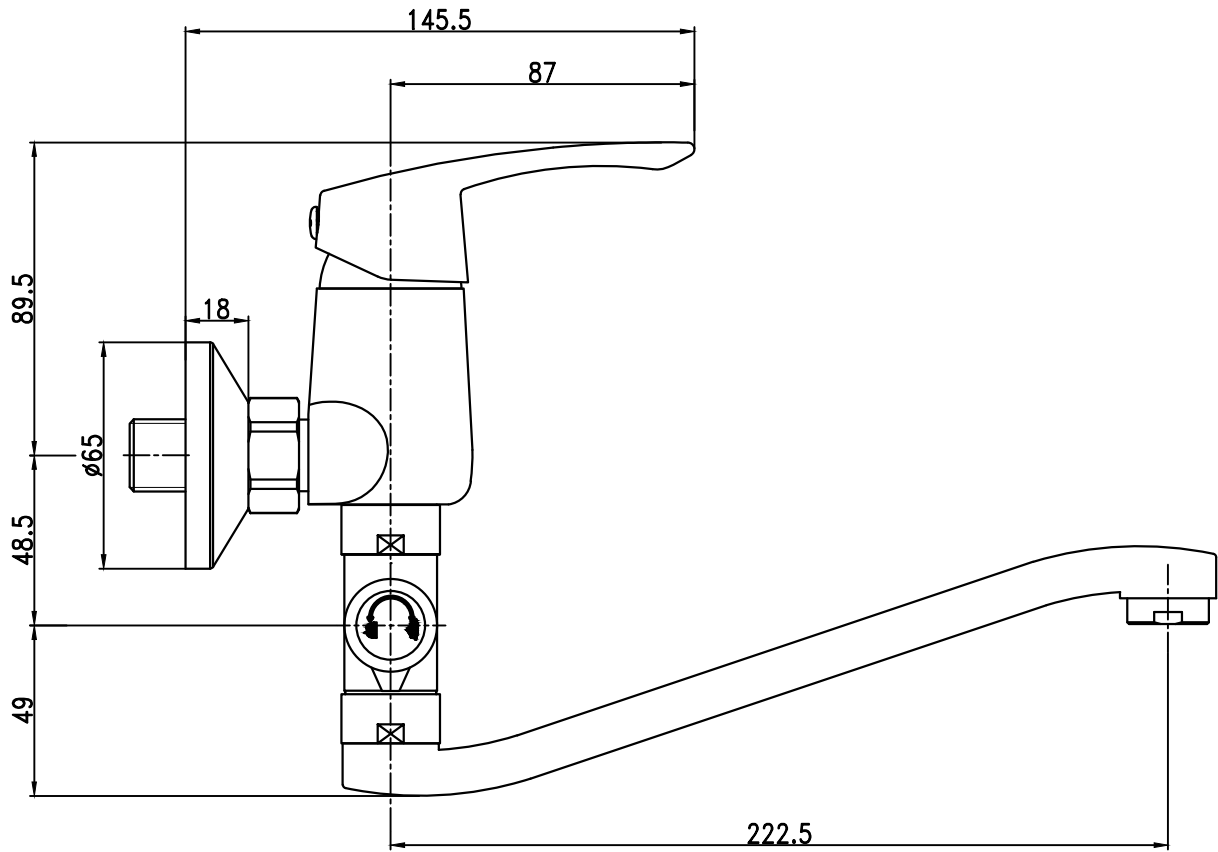

L10 37 20